

Datasheet

Surge protection for measuring systems and automatic control devices

One-piece SPD with low protection level for MCR applications

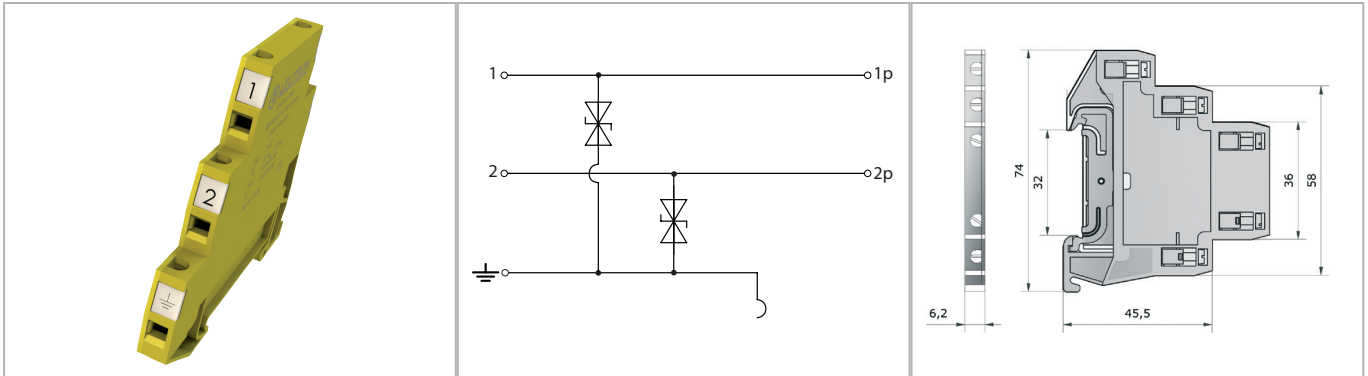

Terminal blocks with integrated surge protection can optimize the used space in a control cabinet and at the same time provide high level protection for terminal equipment and devices.

- Protective circuit for 2 signal lines with common ground
- Applicable at the boundaries LPZ 1 - 2 and higher
- Test standard: IEC 61643-21 / EN 61643-21
- Mounting on 35 mm DIN rail (EN 60715)
- 6.2 mm DIN rail module
- Earthing via DIN rail or connector

Technical Data		MP RK 5V-Ad-Pg
IEC category		C1 / C3
Nominal voltage DC	UN	5V=
Max. continuous operating voltage (DC/AC)	Uc	6/4V
Nominal current	IL	2,0 A
C1 nominal discharge current (8/20 μs) total	In	0,8 kA
C1 nominal discharge current (8/20 μs) per line	In	0,4 kA
Protection level line-line at In C1	Up	≤ 26V
Protection level line-earth at In C1	Up	≤ 13V
Protection level line-line at 1 kV/μs C3	Up	≤ 20V
Protection level line-Pg at 1 kV/μs C3	Up	≤ 10V
Series resistance per line		0 Ω
Max. operating frequency (-3 dB)	fG	typ. 1,0 MHz
Conductor cross section (solid/stranded/AWG)		0.2-4.0/0.2-2.5 mm ² / 24-12
Operating temperature range	TU	-40 - +80 °C
Inflammability class according to UL 94		V0
Degree of protection (IEC EN 60529)		IP 20
Enclosure material / colour		PA6 / yellow
Installation width		6,2 mm
Mounting on		35 mm DIN rail (EN 60715)

Order Data	
Product	MP RK 5V-Ad-Pg
Article-No.	97 10 32