

Datasheet

Surge protection for measuring systems and automatic control devices

One-piece SPD with high discharge capability and low protection level for MCR applications

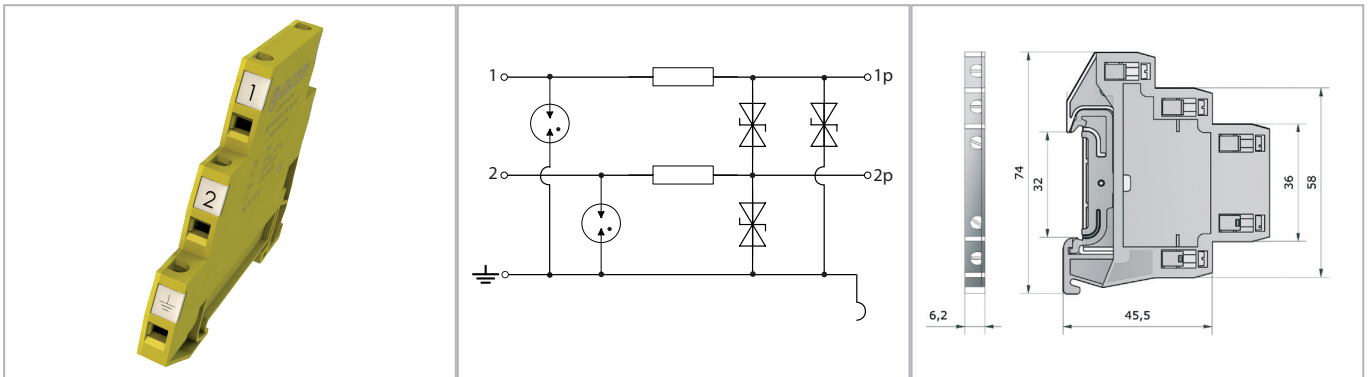

Terminal blocks with integrated surge protection can optimize the used space in a control cabinet and at the same time provide high level protection for terminal equipment and devices.

- Protective circuit for 2 signal lines with common ground
- Applicable at the boundaries LPZ 0B - 2 and higher
- Test standard: IEC 61643-21 / EN 61643-21
- Mounting on 35 mm DIN rail (EN 60715)
- 6.2 mm DIN rail module
- Earthing via DIN rail or connector

Technical Data		MP RK GDT+60V-Ad-Ad-Pg
IEC category		C2 / C1 / C3
Nominal voltage DC	UN	60 V=
Max. continuous operating voltage (DC/AC)	Uc	70/49 V
Nominal current	IL	0,5 A
C2 nominal discharge current (8/20 μs) total	I _{max}	10 kA
C2 nominal discharge current (8/20 μs) per line	I _n	5 kA
Protection level line-line at I _n C2	U _p	≤ 120 V
Protection level line-earth at I _n C2	U _p	≤ 120 V
Protection level line-line at 1 kV/μs C3	U _p	≤ 90 V
Protection level line-Pg at 1 kV/μs C3	U _p	≤ 90 V
Series resistance per line		2,2 Ω
Max. operating frequency (-3 dB)	f _G	typ. 12 MHz
Conductor cross section (solid/stranded/AWG)		0.2-4.0/0.2-2.5 mm ² / 24-12
Operating temperature range	TU	-40 - +80 °C
Inflammability class according to UL 94		V0
Degree of protection (IEC EN 60529)		IP 20
Enclosure material / colour		PA6 / yellow
Installation width		6,2 mm
Mounting on		35 mm DIN rail (EN 60715)
D1 Surge carrying capacity in acc. with IEC 61643-21(Core-Earth)		2,5 kA

Order Data	
Product	MP RK GDT+60V-Ad-Ad-Pg
Article-No.	97 10 23