

Datasheet

Surge protection for measuring systems and automatic control devices

Pluggable SPD with high discharge capability and low protection level for MCR applications

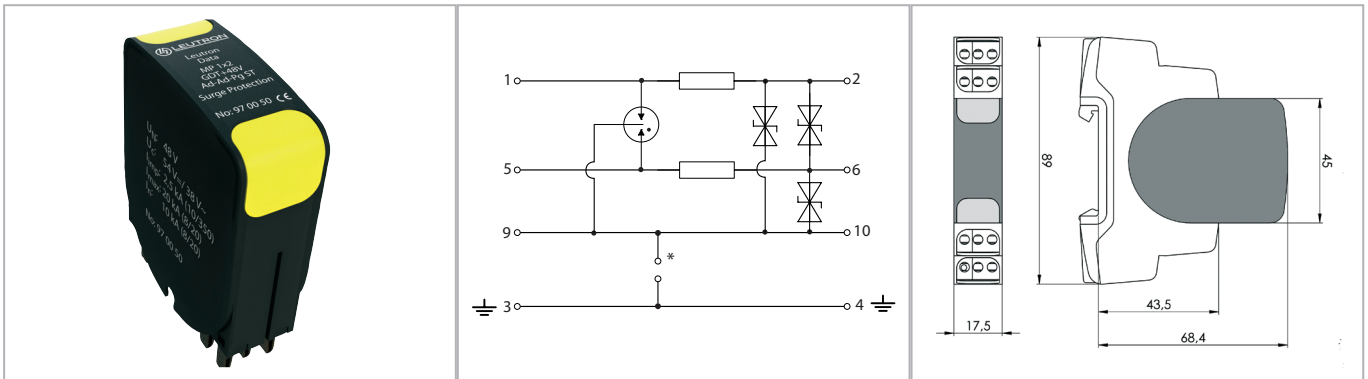

Fully pluggable two-parts arrester for signal lines. The protective module can be removed for test or maintenance purposes without changing the line impedance and therefore influencing the signal level. The base part can remain in the installation without manipulating or removing any wire.

- Protective circuit for 2 signal lines with common ground
- Protective plug can be removed without changing the line impedance or influencing the useful signal
- Test standard: IEC 61643-21 / EN 61643-21
- Vibration test standard: DIN EN 60068-2-6, IEC 60068-2-6
- Shock test standard: DIN EN 60068-2-27, IEC 60068-2-27
- Applicable at the boundaries LPZ 0A - 2 and higher
- Mounting on 35 mm DIN rail (EN 60715)
- Enclosure material: thermoplastic
- Space required for installation: 17.5 mm

Technical Data		MP 1x2 GDT+48V-Ad-Ad-Pg ST
IEC category/EN type		D1 / C2 / C1 / C3
Nominal voltage DC	UN	48V=
Max. continuous operating voltage (DC/AC)	Uc	50/36V
Nominal current	IL	0,5 A
D1 lightning impulse current (10/350) per line	Iimp	2,5 kA
C2 nominal discharge current (8/20 μs) total	I _{max}	20 kA
C2 nominal discharge current (8/20 μs) per line	I _n	10 kA
Protection level line-line at Iimp D1	U _p	≤ 80V
Protection level line-earth at Iimp D1	U _p	≤ 95V
Protection level line-line at 1 kV/μs C3	U _p	≤ 70V
Protection level line-Pg at 1 kV/μs C3	U _p	≤ 70V
Series resistance per line		2,2 Ω
Max. operating frequency (-3 dB)	f _G	typ. 10 MHz
Conductor cross section (solid/stranded/AWG)		0.2-4.0/0.2-2.5 mm ² / 24-12
Operating temperature range	TU	-40 - +80 °C
Inflammability class according to UL 94		V0
Degree of protection (IEC EN 60529)		IP 20
Enclosure material / colour		PA6 / black-yellow
Dimension (DIN 43880)		17.5 mm (1TE)
Mounting on		35 mm DIN rail (EN 60715)

Order Data	
Product	MP 1x2 GDT+48V-Ad-Ad-Pg ST
Article-No.	97 00 50