

Datasheet

Surge protection of power supply

Combined arrester type 1 + 2 for AC power supplies / IsoPro

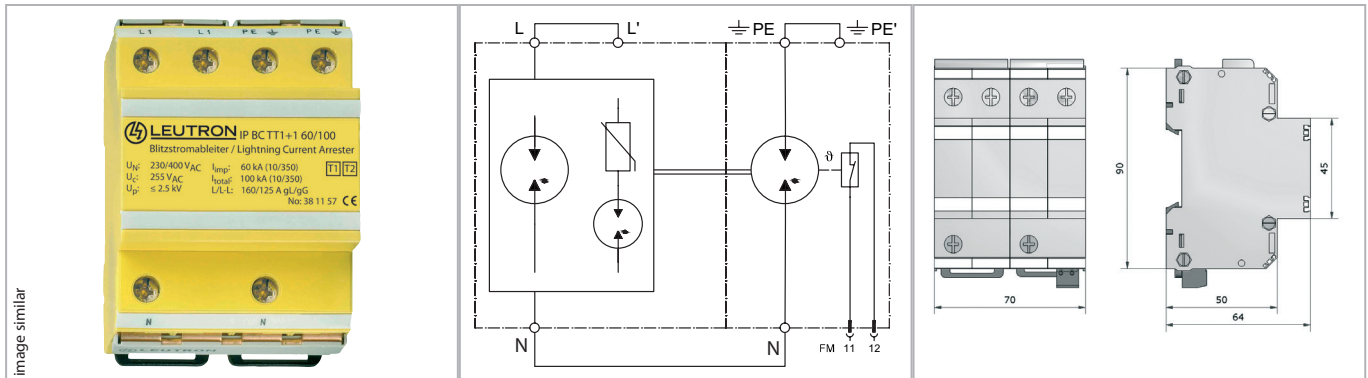

Combined multi-pole arrester for 1-phase TT systems. The arresters can be installed at the transition OA to 2 according to the lightning protection zones concept.

- Test standard: IEC 61643-11 / EN 61643-11
- Class I+II (T1+T2) Combined Arresters
- No leakage currents, thus, allowing installation upstream of power meters
- All-in-one protection unit, ready for connection
- Mounting on 35 mm DIN rail (EN 60715)
- Degree of protection according to IEC EN 60529: IP 20
- Inflammability class according to UL 94 V0
- EAC certification
- Remote signalling contact: break contact

Technical Data		IP BC TT1+1 60/100/FM
IEC category		Type 1 + 2 / class I+II
Nominal voltage AC	UN	230/400 V~
Max. continuous operating voltage AC (50/60 Hz)	Uc	255 V~
Insulation resistance	Risol	>10 GΩ
Protection level at 100% lightning imp. sparkover voltage (1.2/50 μs)	Up	≤ 2,5 kV
Protection level	Up	≤ 2,5 kV
Response time	tA	<50 ns
Lightning impulse current (10/350 μs) total	I _{total}	100 kA
Lightning impulse current (10/350 μs) L-N/N-PE/L-PEN	I _{imp}	60 / 100 / - kA
Short-circuit withstand capability at max. back-up fuse	I _k	50 kA _{eff}
Max. acceptable back-up fuse F2 (spur wiring)		160 A gG
Max. acceptable back-up fuse F1 (serial wiring)		125 A gG
Operating temperature range	TU	-40 - +80 °C
Max. conductor cross section		stranded 50/fine stranded 35 mm ²
Recommended conductor cross section		25 mm ²
Max. connection torque for terminals		4,0 Nm
Enclosure material / colour		polycarbonate (halogen-free) UL 94-V0 / yellow
FM contact / contact type		break contact
Switching capacity FM		250 V/2 A
Max. conductor cross section FM		1,5 mm ²

Order Data

Product	IP BC TT1+1 60/100/FM
Article-No.	38 11 58