

Datasheet

Surge protection of power supply

SPD Type 3 for AC power supplies

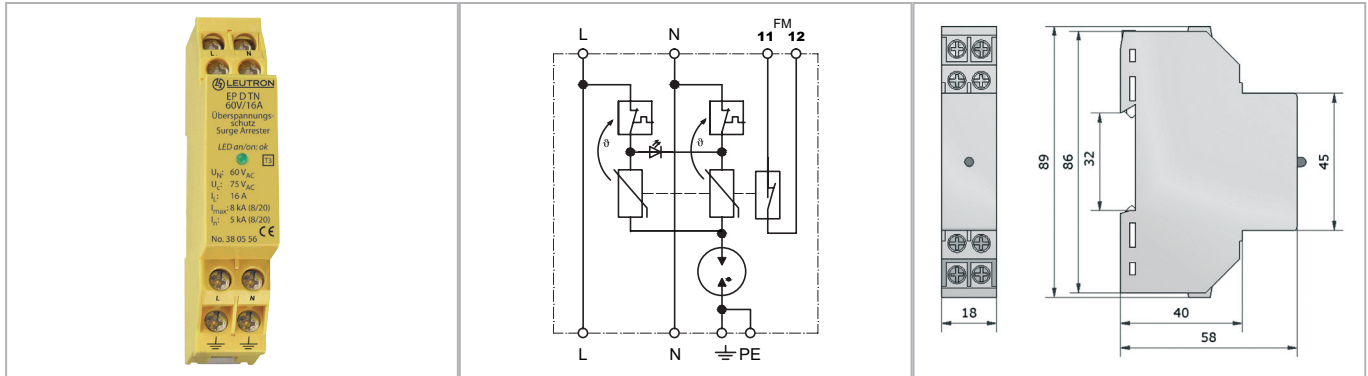

Compact 2-pole surge arrester type 3 (class III) for the use in TN systems. The SPD is applicable at the transition 2-3 according to the lightning protection zones concept.

- Test standard: IEC 61643-11 / EN 61643-11
- Line function and equipment control by LED
- Leakage current free
- Practical compact housing with minimum space requirement
- EAC certification
- Remote changeover contact

Technical Data		EP D TN 60V/16A/FM
IEC category		Type 3
Nominal voltage AC	UN	60 V~
Nominal voltage DC	UN	60 V=
Max. continuous operating voltage AC (50/60 Hz)	Uc	75 V~
Max. continuous operating voltage DC	Uc	75 V=
Rated load current	IL	16 A
Protection level L-N	Up	≤ 0,5 kV
Protection level L/N-PE	Up	≤ 1,0 kV
Combined surge	Uoc	≤ 2 kV
Response time L-N/L,N-PE		≤ 25/≤ 100 ns
Nominal impulse discharge current (10 x 8/20 μs)	In	5 kA
Max. impulse discharge current (8/20 μs)	Imax	8 kA
Max. allowed fuse or back-up fuse		16 A gG
Operating temperature range	TU	-40 - +80 °C
Min. conductor cross section at terminals		1.5 mm ² single-wire / 1.0 mm ² flexible with sleeve
Max. conductor cross section		2.5 mm ² single-wire / 1.5 mm ² flexible with sleeve
Max. connection torque for terminals		1,5 Nm
Enclosure material / colour		polycarbonate (halogen-free) UL 94-V0 / yellow
Degree of protection (IEC EN 60529)		IP 20
Mounting on		35 mm DIN rail (EN 60715)

Order Data

Product	EP D TN 60V/16A/FM
Article-No.	38 05 57