

## EMC filter with integrated surge protection

### MCR technology with integrated low-pass filter

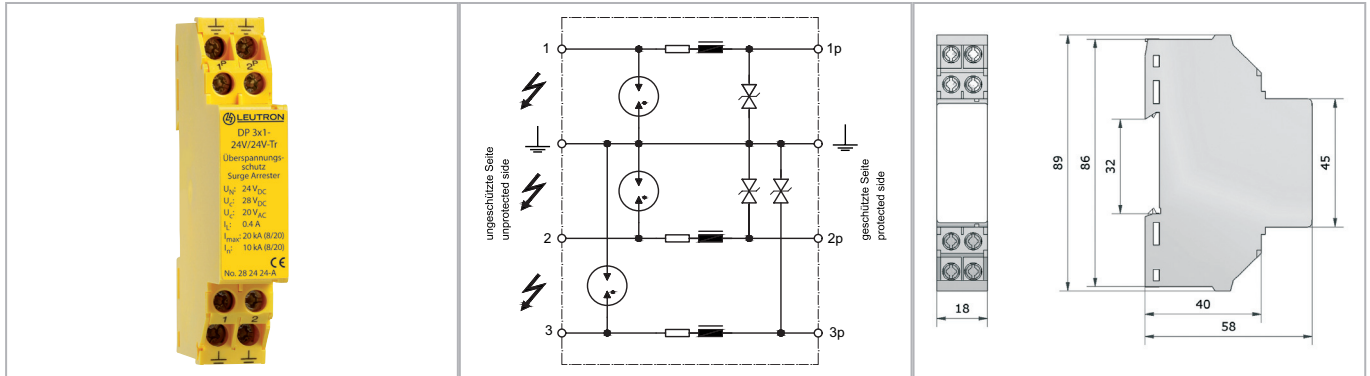

EMC filter for data and signal lines combined with surge protection enables smooth operation of sensitive electronic equipment in rough environment.

- Signal and data line protection with low-pass filter
- Protective circuit for 3 signal lines with common ground
- Applicable at the boundaries LPZ 0A - 2 and higher
- Mounting on 35 mm DIN rail (EN 60715)
- Degree of protection according to IEC EN 60529: IP 20
- Space required for installation: 18 mm
- EAC certification

Technical Data		DP 3x1-24V/24V-Tr
IEC category		D1 / C2 / C1 / C3
Nominal voltage DC	UN	24V=
Max. continuous operating voltage DC	Uc	28V=
Max. continuous operating voltage AC (50/60 Hz)	Uc	20V~
Nominal current	IL	0,4 A
D1 lightning impulse current (10/350 µs) per line	Iimp	2,5 kA
D1 lightning impulse current (10/350 µs) total	Itotal	7,5 kA
C2 nominal discharge current (8/20 µs) per line	In	10 kA
C2 nominal discharge current (8/20 µs) total	I <sub>max</sub>	20 kA
Protection level at In (line-earth)	Up	≤ 36 V
Leakage current at U <sub>max</sub> DC		≤ 5 µA
DC resistance	R	3,2 Ω
Series inductance, typ.	L	30 µH
Capacitance, line-earth	C	≤ 1,3 nF
Max. operating frequency (-3 dB)	fG	600 kHz
Operating temperature range	TU	-25 - +85 °C
Max. conductor cross section		2.5mm <sup>2</sup> solid or 1.5mm <sup>2</sup> flexible with sleeve
Max. connection torque for terminals		1,5 Nm
Enclosure material / colour		polycarbonate (halogen-free) UL 94-V0 / yellow
Degree of protection (IEC EN 60529)		IP 20

Order Data	
Product	DP 3x1-24V/24V-Tr
Article-No.	28 24 24-A