

# Datasheet

## Surge protection for information technology and telecommunication installations

### Cat5 Application

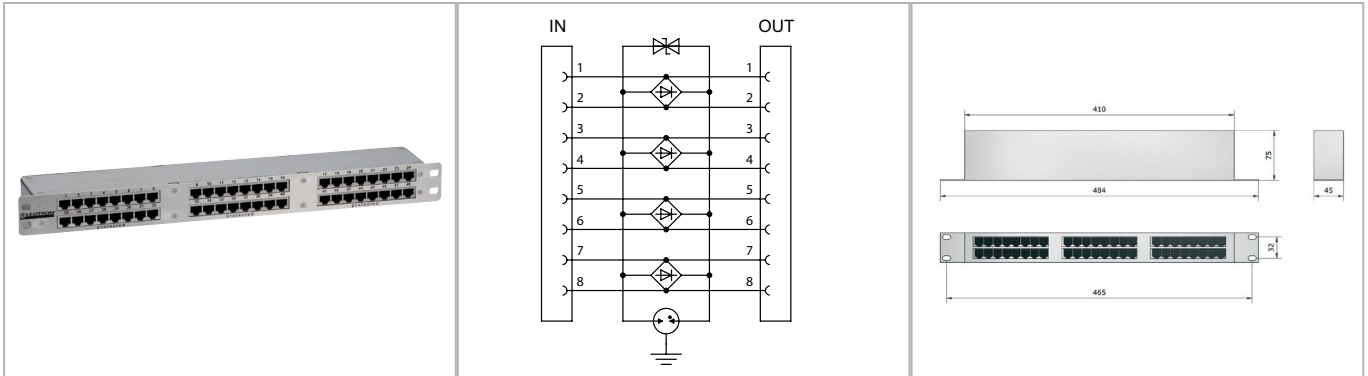

Compact surge protective module in 19" housing with only 1 HE (45 mm) for the protection of data networks and network devices such as hubs, switches, server and desktop computer. Easy installation and wiring in all 19" distribution and server racks possible. •All 8 signal lines (4 pair of wires) are protected simultaneously.

- Applicable at the boundaries LPZ 1 - 2 and higher
- Fully shielded 19" housing can be equipped with up to 24 RJ45 protection ports
- Suitable for Cat. 5 / class D applications (up to Gbit Ethernet)
- Compatible to 10Base T / 100Base T
- Test standard: IEC 61643-21 / EN 61643-21
- Additional modules for the protection of up to 24 ports can be installed optionally
- EAC certification

Technical Data		DP 6x8RJ45-19"
IEC category		C2 / C1 / C3
Nominal voltage DC	UN	6V=
Max. continuous operating voltage DC	Uc	8,1V=
Nominal current per line	IL	100 mA
C1 nominal discharge current (8/20 μs) per line	In	200 A
C2 Total discharge current (8/20 μs) line-earth (PE)	Imax	2,5 kA
C1 protection level line-line at In	Up	≤ 45 V
C1 protection level line-PE at In	Up	≤ 350 V
C3 protection level line-line at 1 kV/μs	Up	≤ 40 V
C3 protection level line-PE at 1kV/μs	Up	≤ 350 V
Response time line-line/ line-shield	tA	< 1 ns
Response time line-PE; PE-shield	tA	< 100 ns
Max. frequency	fG	100 MHz
Operating temperature range	TU	-40 - +80 °C
Terminal input/output		48× RJ45, shielded
Degree of protection (IEC EN 60529)		IP 20
Housing material		stainless steel

Order Data	
Product	DP 6x8RJ45-19"
Article-No.	19 40 63